



PRODUCT SPECIFICATIONS

Module No.: NTD-7.0T1024600R100A

TFT(Thin-Film-Transistor) Color Liquid Crystal Display Module

General Specification

- 7.0 inch Diagonal
- 1024xRGBx600 resolution
- 24 bit RGB interface
- LED Backlight (200cd/m²)
- 16.7 M colors
- 12:00 O'clock Optimal View
- RoHS Compliant

For Customer's Acceptance:

Approved By	Comment

From: NewTrend Display Technology Co., Ltd.

--

Outline Drawing

SYMBOL	REVISION		DATE
V0	First		

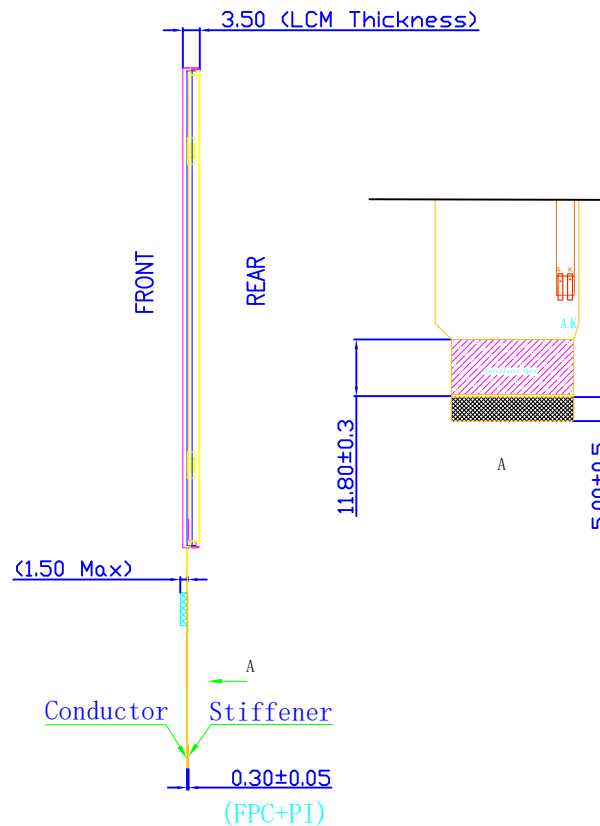
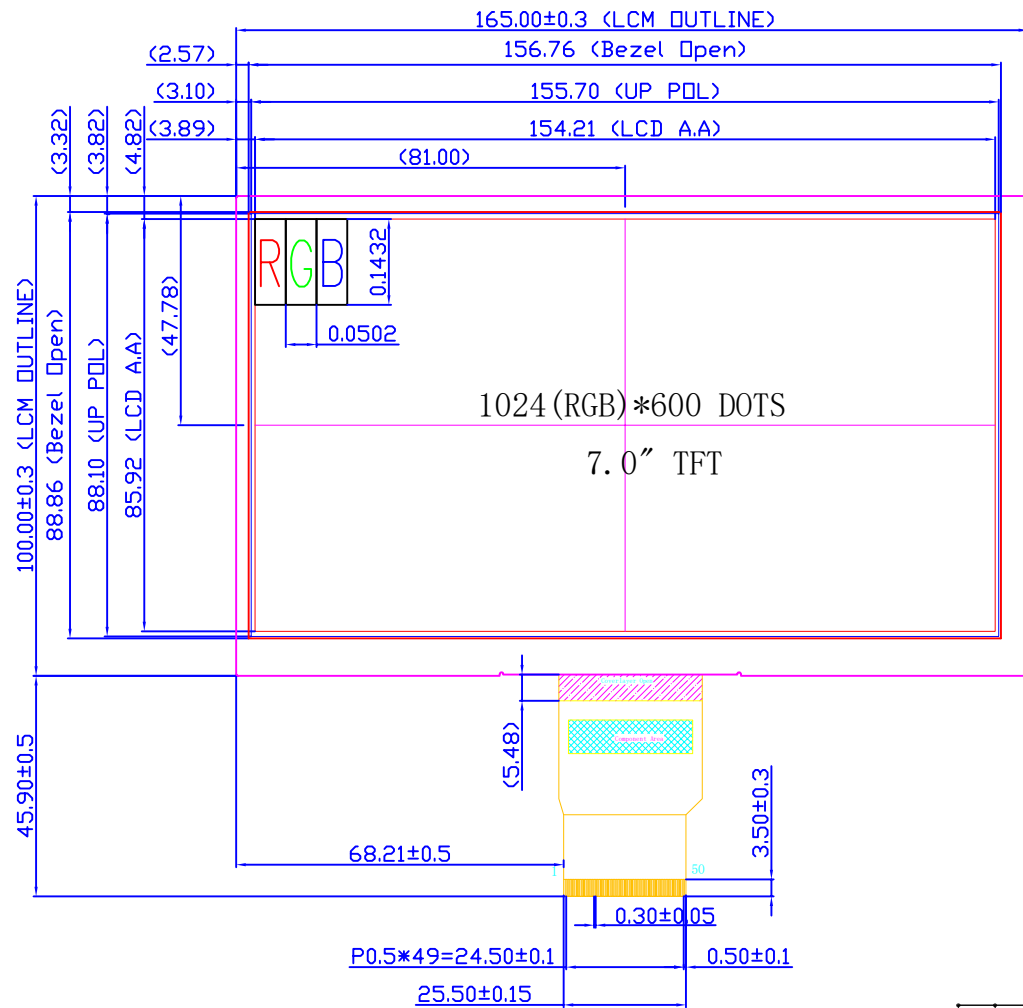

PIN NO.	SYMBOL
1	VLEDA
2	VLEDA
3	VLEDK
4	VLEDK
5	GND
6	VCOM
7	DVDD
8	MODE
9	DE
10	VS
11	HS
12~19	B7~B0
20~27	G7~G0
28~35	R7~R0
36	GND
37	DCLK
38	GND
39	L/R
40	U/D
41	VGH
42	VGL
43	AVDD
44	RESET
45	NC
46	VCOM
47	DITHB
48	GND
49	NC
50	NC

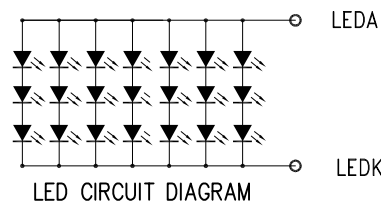

SCAN DIRECTION SETTING

L/R	U/D	Data Shifting
DVDD	GND	Left→Right, Up→Down(default)
GND	GND	Right→Left, Up→Down
DVDD	DVDD	Left→Right, Down→Up
GND	DVDD	Right→Left, Down→Up

NOTES:

1. DISPLAY TYPE: 7.0" TFT, Transmissive, Normally White
2. OPTIMUM VIEWING : 12:00
3. Top: -10°C~+60°C, Tst: -20°C~+70°C
4. TFT Interface :24-bit RGB Interace, DVDD=3.3±0.3V
5. LCM Luminance:LED/200cd/m (TYP)² IF=140mA,VF=9.0V(TYP)
6. RoHS

UNLESS OTHERWISE SPECIFIED Unit:mm THIRD ANGLE PROJECTION:		NewTrend Display Technology	
UNLESS OTHERWISE NOTED TOLERANCES :±0.2mm		DRAWING_NO. NTD-7.0T1024600R100A	
SCALE	SHEET	DRAWN BY:	APPROVED BY:
1:1	1 OF 1		

Pin Description:

Pin No.	Symbol	Function Description	Remark
1~2	LEDA	LED backlight (Anode).	
3~4	LEDK	LED backlight (Cathode).	
5	GND	Ground.	
6	VCOM	Common Voltage.	
7	DVDD	Digital Power.	
8	MODE	DE/SYNC mode select. Normally pull high. H: DE mode. L: HSD/VSD mode.	
9	DE	Data enable input. Active high to enable the input data bus.	
10	VSYNC	Vertical sync input. Negative polarity.	
11	HSYNC	Horizontal sync input. Negative polarity.	
12~19	B7~B0	Blue Data Input	
20~27	G7~G0	Green Data Input	
28~35	R7~R0	Red Data Input	
36	GND	Ground	
37	DCLK	Clock Input	
38	GND	Ground	
39	L/R	Left or Right Display Control.	NOTE1
40	U/D	Up / Down Display Control.	NOTE1
41	VGH	Positive Power for TFT.	
42	VGL	Negative Power for TFT.	
43	AVDD	Analog Power.	
44	RESET	Global reset pin. Active low to enter reset state. Suggest to connecting with an RC reset circuit for stability. Normally pull high.(R=10KΩ, C=1μF)	
45	NC	No connection	
46	VCOM	Common Voltage.	
47	DIHTB	Dithering function enable control. (Normally pull high) DITHB="L", to enable internal dithering function. DITHB="H", to disable internal dithering function.	
48	GND	Ground.	
49~50	NC	No connection.	

【Note1】 L/R : left or right setting
U/D : up or down setting

L/R	U/D	Data shifting
DVDD	GND	Left → Right, Up → Down(default)
GND	GND	Right → Left, Up → Down
DVDD	DVDD	Left → Right, Down → Up
GND	DVDD	Right → Left, Down → Up

Definition of scanning direction:

Definition of scanning direction:

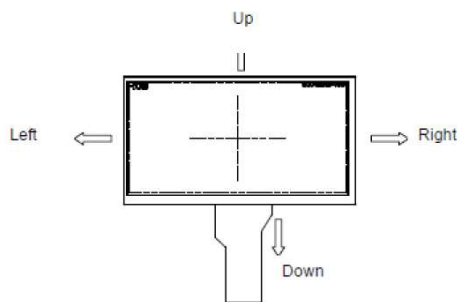

DC Electrical Characteristics

Item	Symbol	Condition	Min.	Typ.	Max.	Unit
Operating Temperature Range	Top	Absolute Max	-10	-	+60	°C
Storage Temperature Range	T _{ST}	Absolute Max	-20	-	+70	°C
Digital Supply Voltage	DV _{DD}	-	3.0	3.3	3.6	V
Analog Supply Voltage	AV _{DD}	-	8.6	9.6	11.0	V
Gate On Voltage	V _{GH}	-	18	19	20	V
Gate Off Voltage	V _{GL}	-	-8.0	-7.5	-6.5	V
Common Voltage	V _{COM}	-	3.2	4.0	4.8	V
Input logic high voltage	V _{IH}	-	0.7*DV _{DD}	-	DV _{DD}	V
Input logic low voltage	V _{IL}	-	GND	-	0.3*DV _{DD}	V

Note 1: Please adjust V_{COM} to make the flicker level be minimum. Typ V_{COM} Voltage value is only for reference, subject to the actual effect (adjustable according to FLICKER status)

Item	Symbol	Condition	Min.	Typ.	Max.	Unit
Backlight Supply Voltage	v _f	Top=25°C I _f =140mA	8.1	9.0	9.9	V
Backlight Supply Current	I _f		-	140		mA
Backlight Lifetime	-	Top=25°C I _f =140mA	20000			Hrs

*Backlight lifetime is rated as Hours until half-brightness, under normal operating conditions. The LED of the backlight is driven by current drain, drive voltage is for reference only. Drive voltage must be selected to ensure backlight current drain is below MAX level stated.

Optical Characteristics

Item	Symbol	Condition	Min.	Typ.	Max.	Unit
Operating Viewing Angles	Top	-	CR≥10	50	-	Deg
	Bottom	-		70	-	
	Left	-		70	-	
	Right	-		70	-	
Contrast Ratio	CR	Center	600	800	-	-
Luminance	L _v		150	200		cd/m ²
Response Time	Tr+Tf			25	50	ms
Chromaticity	Red	X _R	-	TYP-0.05	TYP+0.05	-
		Y _R				
	Green	X _G	-			
		Y _G				
	Blue	X _B	-			
		Y _B				
	White	X _w	-			
		Y _w	-			

Note (1) Measurement Setup: The LCD module should be stabilized at given temp. 25°C for 15 minutes to avoid abrupt temperature change during measuring. In order to stabilize the luminance, the measurement should be executed after lighting backlight for 15 minutes in a windless room.

Power Sequence

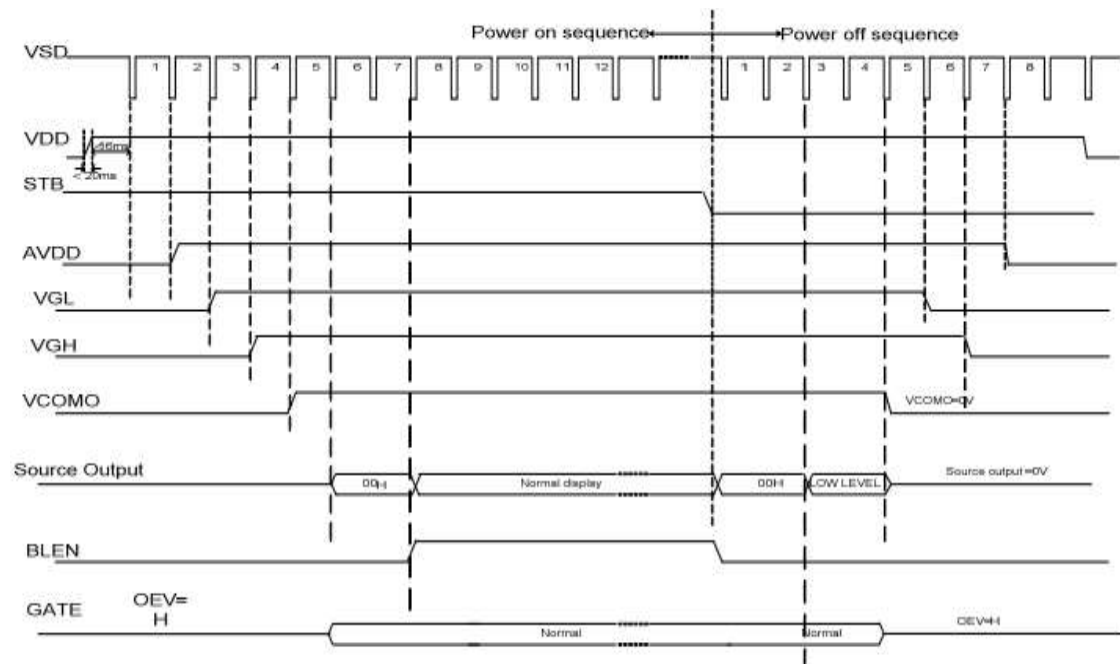

Power On/Off timing chart

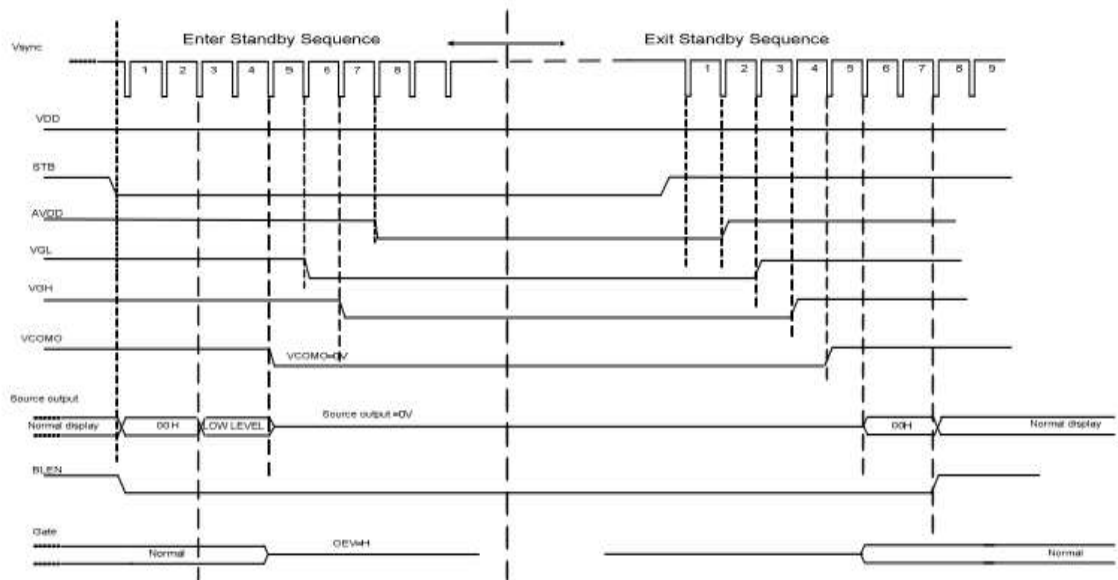

Enter and Exit Standby Mode timing chart

Note: Low level=3Fh, when NBW=L(Normally white)
 Low level=00h, when NBW=H(Normally black)

AC Electrical Characteristics

Vertical Input timing

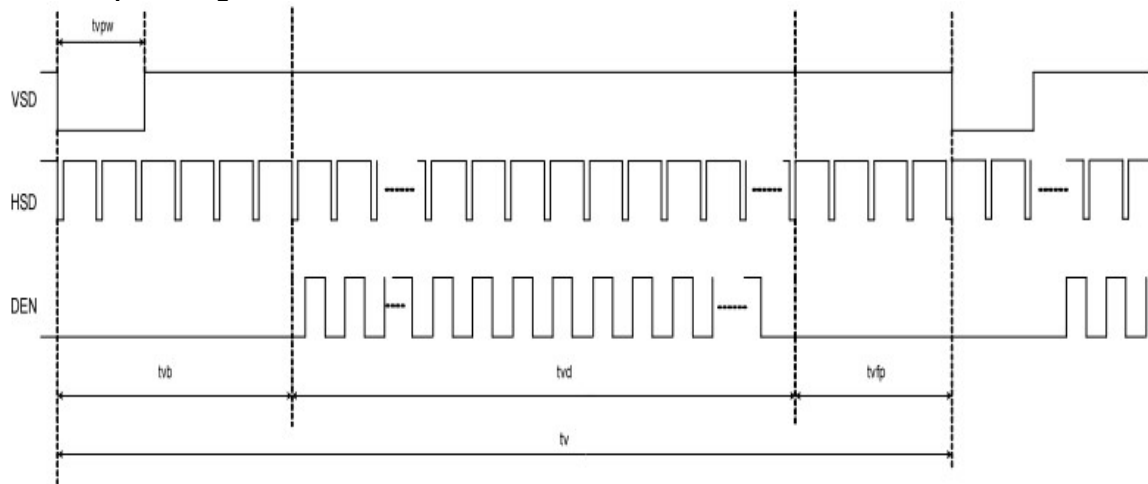

Horizontal input timing

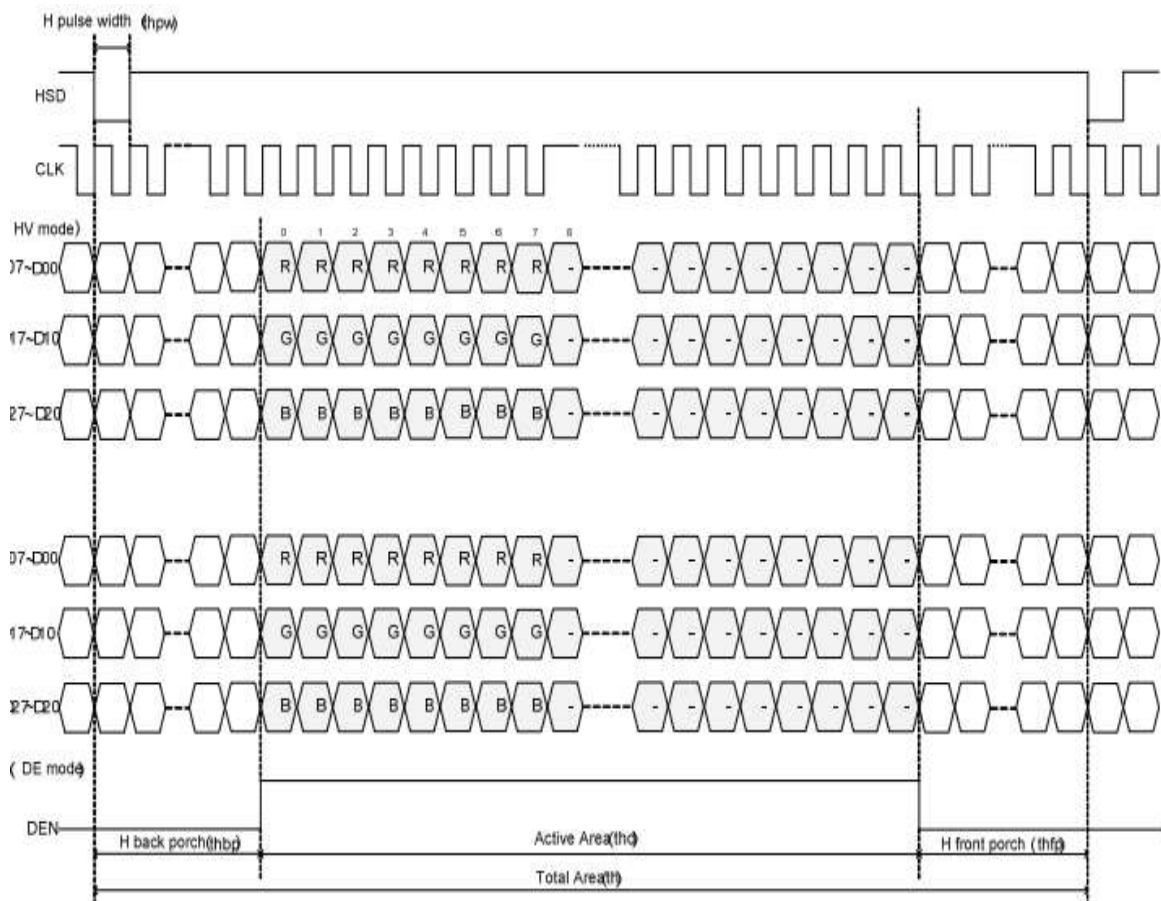

Horizontal input timing

DE mode

DE mode					
Parameter	Symbol	Value			Unit
		Min.	Typ.	Max.	
DCLK frequency @Frame rate=60hz	fclk	40.8	51.2	67.2	Mhz
Horizontal display area	thd	1024			DCLK
HSYNC period time	th	1114	1344	1400	DCLK
HSYNC blanking	thb+thfp	90	320	376	DCLK
Vertical display area	tvd	600			H
VSYNC period time	tv	610	635	800	H
VSYNC blanking	tvb+tvfp	10	35	200	H

HV mode

HV mode					
Horizontal input timing					
Parameter	Symbol	Value			Unit
Horizontal display area	thd	1024			DCLK
DCLK frequency@ Frame rate=60hz	fclk	Min.	Typ.	Max.	Mhz
		44.9	51.2	63	
1 Horizontal Line	th	1200	1344	1400	DCLK
HSYNC pulse width	thpw	Min.	1		
		Typ.	—		
		Max.	140		
HSYNC back porch	thbp	160	160	160	
HSYNC front porch	thfp	16	160	216	

Vertical input timing					
Parameter	Symbol	Value			Unit
		Min.	Typ.	Max.	
Vertical display area	tvd	600			H
VSYNC period time	tv	624	635	750	H
VSYNC pulse width	tvpw	1	—	20	H
VSYNC back porch	tvb	23	23	23	H
VSYNC front porch	tvfp	1	12	127	H

Reliability Test Items and Criteria

No	Test Item	Test condition	Criterion
1	High Temperature Storage	70°C±2°C 96H Restore 4H at 25°C , Power off	1. After testing, cosmetic and electrical defects should not happen. 2. Total current consumption should not be more than twice of initial value.
2	Low Temperature Storage	-20°C±2°C 96H Restore 4H at 25°C , Power off	
3	High Temperature Operation	60°C±2°C 96H Restore 4H at 25°C , Power on	
4	Low Temperature Operation	-10°C±2°C 96H Restore 4H at 25°C , Power on	
5	High Temperature/Humidity Storage	50°C±2°C 90%RH 96H Power off	
6	Temperature Cycle	$ \begin{array}{ccccccc} & -20^{\circ}\text{C} & \rightarrow & +25^{\circ}\text{C} & \rightarrow & 70^{\circ}\text{C} & \rightarrow & +25^{\circ}\text{C} \\ & (30\text{mins}) & & (5\text{mins}) & & (30\text{mins}) & & (5\text{mins}) \\ & \longleftarrow & & & & & & \longrightarrow \\ & & & & & & & \text{5 Cycle} \\ & & & & & & & \text{Restore 4H at 25}^{\circ}\text{C} , \text{ Power off} \end{array} $	

Precautions for Use of LCD Modules

1. Handling Precautions

1.1 The display panel is made of glass. Do not subject it to a mechanical shock by dropping it from a high place, etc.

1.2 If the display panel is damaged and the liquid crystal substance inside it leaks out, be sure not to get any in your mouth, if the substance comes into contact with your skin or clothes, promptly wash it off using soap and water.

1.3 Do not apply excessive force to the display surface or the adjoining areas since this may cause the color tone to vary.

1.4 The polarizer covering the display surface of the LCD module is soft and easily scratched. Handle this polarizer carefully.

1.5 If the display surface is contaminated, breathe on the surface and gently wipe it with a soft dry cloth. If still not completely clear, moisten cloth with one of the following solvents:

— Isopropyl alcohol — Ethyl alcohol

Solvents other than those mentioned above may damage the polarizer. Especially, do not use the following:

— Water — Ketone — Aromatic solvents

1.6 Do not attempt to disassemble the LCD Module.

1.7 If the logic circuit power is off, do not apply the input signals.

1.8 To prevent destruction of the elements by static electricity, be careful to maintain an optimum work environment.

a. Be sure to ground the body when handling the LCD Modules.

b. Tools required for assembly, such as soldering irons, must be properly ground.

c. To reduce the amount of static electricity generated, do not conduct assembly and other work under dry conditions.

d. The LCD Module is coated with a film to protect the display surface. Be care when peeling off this protective film since static electricity may be generated.

2. Storage precautions

2.1 When storing the LCD modules, avoid exposure to direct sunlight or to the light of fluorescent lamps.

2.2 The LCD modules should be stored under the storage temperature range. If the LCD modules will be stored for a long time, the recommend condition is:

Temperature : 10°C ~ 40°C

Relatively humidity: ≤60%

2.3 The LCD modules should be stored in the room without acid, alkali and harmful gas.

3. The LCD modules should be no falling and violent shocking during transportation, and also should avoid excessive press, water, damp and sunshine.